

INSTRUCTIONS FOR USE

Arsenal Plating System



900-01-019 Rev A
September 2019

Description

The Arsenal Plating System is comprised of a variety of contoured titanium alloy plates with different shapes and sizes designed for internal fixation of small bone fragments. The Arsenal Plating System utilizes threaded standard and locking bone screws in diameters of 2.2mm (6-20mm long), 2.7mm (8-30mm long) and 3.5mm (8-50mm long). Available plates, screws and instrumentation will be packaged as a single system. System instrumentation includes drill bits, countersinks, reamers, guide wires, olive wires, depth gauges, bone clamps, distraction pliers, bending instruments, drill guides, a screw removal tool, driver shafts, a placement guide and handles to facilitate the placement of the implants.

Implant Materials

All Arsenal Plating System plates and screws are made from Titanium Alloy (ASTM F-136). The instrumentation is made from medical grades of titanium, stainless steel, anodized aluminum, and plastic.

Indications

The Arsenal Plating System is intended for use in trauma and reconstructive procedures of the small bones in the hand/foot, ankle, and other bones appropriate for the size of the device. The plates (implants), screws (implants), olive wires (instruments), and guide wires (instruments) are intended for single use only.

Contraindications

Use of the Arsenal Plating System is contraindicated in cases of active or suspected infection or in patients who are immunocompromised; in patients previously sensitized to titanium; or in patients with certain metabolic diseases. It is further contraindicated in patients exhibiting disorders that would cause the patient to ignore the limitations of internal fixation.

Warnings

1. Re-operation to remove or replace implants may be required at any time due to medical reasons or device failure. If corrective action is not taken, complications may occur.
2. Use of an undersized implant in areas of high functional stresses may lead to implant fracture and failure.
3. Instruments, guide wires, olive wires, and screws are to be treated as sharps.
4. Re-use of devices indicated as single use can result in decreased mechanical and clinical performance of devices.

Maintaining Device Effectiveness

1. The surgeon should have specific training, experience, and thorough familiarity with the use of plating systems.
2. The surgeon must exercise reasonable judgment when deciding which plate and screw type to use for specific indications.
3. The Arsenal Plating System is not intended to endure excessive abnormal functional stresses.
4. The Arsenal Plating System is intended for temporary fixation only until osteogenesis occurs.
5. All Arsenal Plating System implants and instrumentation may be required for each surgery. Failure to use dedicated, unique Trilliant Surgical instruments for every step of the implantation technique may compromise the integrity of the implanted device, leading to premature device failure and subsequent patient injury. Failed devices may require re-operation and removal.
6. Carefully inspect the implants prior to use, inspect the instruments before and after each procedure to ensure they are in proper operating condition. Instruments that are faulty, damaged or suspect should not be used.
7. Trilliant Surgical recommends the use of products in a sterile environment.

Instructions for Use, Arsenal Plating System

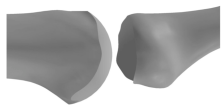

1. Identify, expose, and prepare the surgical site.
2. If performing 1st metatarsal phalangeal joint fusion, joint reaming is recommended. (Fully release any ligaments around the joint, select appropriate sized concave reamer and initiate reamer down central axis of the metatarsal head until the cartilage is removed, then select appropriate sized convex reamer and initiate reamer down the central axis of the phalangeal base until the cartilage is removed. If reamers are not elected for use, a burr, rongeur, or saw blade, can be used to remove the cartilage.)

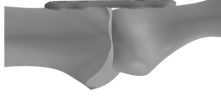

3. Reduce fracture, osteotomy, or fusion site.
4. Select appropriate plate for fixation of fracture, osteotomy, or fusion.
5. Though plates are pre-contoured, slight adjustments may be required and made using the plate bending instruments.

Warning: Excessive or multiple plate bends could cause weakness in the plate.

6. Apply the plate to the prepared site, plate may be temporarily fixated with either olive wires or K-wires.

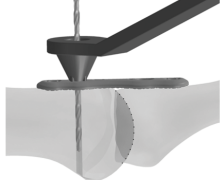

7. Select desired screw diameter to use and corresponding pilot drill.
8. Select the corresponding drill guide and place it into the first plate hole nearest the fracture line or osteotomy site. Make sure the first hole selected is NOT a compression hole.
9. Drill the pilot hole with the corresponding drill diameter at the desired angle of approach through the drill guide. Note: It is recommended to irrigate during pilot drilling.

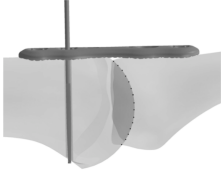

10. Insert the depth gauge in the pilot hole to determine screw length.

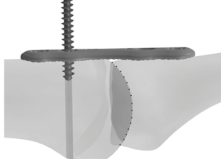

11. Select desired screw length and type. Insert screw into pilot hole and drive into position with driver.

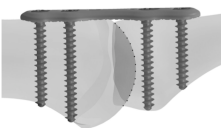

12. If dynamic compression is desired, the next hole drilled should be in the compression hole opposite the fracture line or osteotomy of the initially placed screw. Place the appropriate diameter compression drill guide in the compression hole of the plate. Point arrow on the drill guide towards the direction of desired compression. Continue with steps 9-12;

NOTE: The compression hole can only accept standard screws.

13. Repeat steps 7-12 until all desired screw holes are filled. When placing additional screws, make sure placement does not interfere with other screws.

Instructions for Use, Solid Core Screws (Optional)

An interfragmentary screw may be used in conjunction with a plate. If using a solid core screw, follow the lag technique for solid core fully threaded screws.

1. Reduce the fracture, osteotomy, or fusion site.
2. Place the desired diameter drill guide on determined site for screw placement. Drill glide hole in proximal cortex/section of bone.
3. Place the corresponding drill guide inside glide hole and drill pilot hole through distal cortex using the appropriate pilot drill.
4. Countersink the proximal cortex.
5. Using the depth gauge, determine the length of the screw required.
6. Select the appropriate screw length and insert rotating clockwise with the driver until the desired position is achieved.

Plate Removal (If Necessary)

1. Locate plate and screws with intra-operative imaging.
2. Palpate plate and remove surrounding soft tissue to gain maximum exposure.
3. Engage screw heads with appropriate driver and rotate counter-clockwise until screws are removed.
4. Use forcep or pickup to remove plate.
5. All devices removed should be treated as medical waste and disposed of accordingly.

Cleaning

Non-sterile products must be carefully and thoroughly cleaned prior to sterilization. Trained personnel must perform cleaning and mechanical inspection prior to sterilization. Compliance is required with the equipment manufacturer's user instructions (manual and/or machine cleaning, ultrasound treatment, etc.) and recommendations for chemical detergents. For validated cleaning instructions, please reference document 900-06-021, Arsenal Plating System Cleaning and Sterilization Protocol.

Packaging and Sterility

NON-STERILE PRODUCT

The Arsenal Plating System (instruments and implants) can be packaged non-sterile and therefore must be sterilized prior to surgical use. Use of the sterilizer shall comply with the manufacturer's user instructions. The user facility must thoroughly clean and disinfect instruments prior to sterilization per standard hospital procedures. Non-sterile devices are sterilizable by steam sterilization (autoclaving). The following parameters should be followed:

Sterilization Method	Pre-Vacuum Steam
Condition	Wrapped*
Temperature	270°F (132°C)
Time	4 minutes
Recommended Dry Time	60 minutes

* The system shall be packaged for sterilization by double wrapping in an FDA cleared wrap and wrapping techniques outlined per ANSI/AAMI ST79, then adhered with FDA cleared chemical indicator autoclave tape.
Note: Do not stack trays during sterilization.









CAUTION

Federal Law (USA) restricts this device to sale by or on the order of a physician. Do not attempt a surgical procedure with faulty, damaged or suspect Trilliant Surgical instruments or implants. Inspect all components preoperatively to assure utility.

MRI Safety Information

The Arsenal Plating System has not been evaluated for safety and compatibility in the MR environment. It has not been tested for heating, migration, or image artifact in the MR environment. The safety of Arsenal Plating System in the MR environment is unknown. Scanning a patient who has this device may result in patient injury.

Symbols Glossary

Symbol	Description	Designation Number, ISO 15223-1:2016
	Catalog Number	5.1.5
	Batch Code	5.1.6
	Do not use if package is damaged	5.2.8
	Do not reuse	5.4.2
	Non-Sterile	5.2.7
	Device only to be sold on or by the order of a physician	N/A*
	Manufacturer	5.1.1
	Caution	5.4.4
	Consult instructions for use	5.4.3

*Symbol allowed under 21 CFR 801. The above symbols are outlined in ISO 15223-1:2016 Medical devices -- Symbols to be used with medical device labels, labeling and information to be supplied -- Part 1: General requirements.

Note: QTY is an abbreviation of "QUANTITY".

Please contact company for product inquiries and surgical techniques, or to report any adverse experience.

This document is controlled by Trilliant Surgical. When downloaded, printed, and/or copied, this document becomes UNCONTROLLED and users should always check Trilliant Surgical's website, www.trilliantsurgical.com, to ensure they have the latest version.

